

## Bracket Installation

**Mounting the brackets level is essential for proper operation of the shade.**

Shim the brackets if necessary to achieve a level alignment.

The bracket requirements and placements are the same for inside and outside mounts.



Installation Brackets

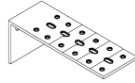

Extension Bracket (optional)

Shade Width	Brackets Required
18" to 38"	2
38-1/8" to 72"	3
72-1/8" to 106"	4
106-1/8" to 140"	5
Over 140"	6

### 1. Install the Brackets

**IMPORTANT:** If you are fastening the installation brackets to drywall, be sure to use wall anchors and follow the instructions provided with the anchors. (Anchors not provided). Use a 3/32" drill bit to drill holes for the screws.

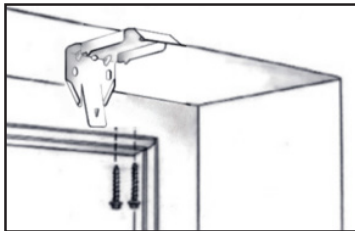

Minimum Depth	Fully Recessed
3/4"	2-1/8"

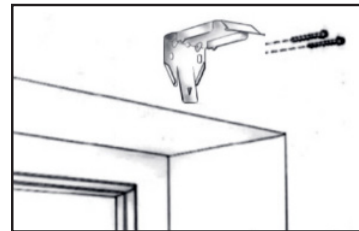

Minimum Height
1-1/2"

**Inside Mount,** Prior to mounting the brackets, add any clearance depth required to avoid obstructions such as window cranks or handles. Refer to the mounting depth chart above. Install the brackets level and aligned to each other, using the screws provided. Ensure all brackets are level and aligned.

**Outside Mount,** Install the brackets level and aligned to each other, using the screws provided. Refer to the minimum surface height chart above. Ensure all brackets are level and aligned.

### 2. Extension Brackets (Optional)

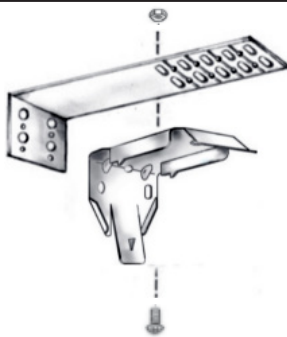

First, position the extension brackets to the desired wall location and mark the position. Ensure bracket tops are aligned and level to one another.

Mount the extension brackets through the back holes with two screws (1), then attach installation brackets to extension brackets with included screws & nuts (2). **IMPORTANT:** Use the same holes for all brackets to ensure even projection from the surface.

### 3. Side Mount with Extension Brackets (Optional)

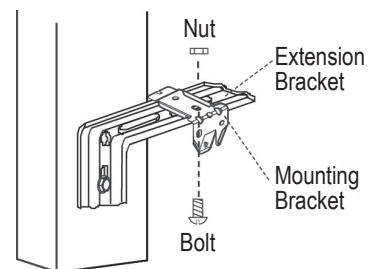

Measure from window sill up to desired mounting position on each side of the window frame and mark the position.

Mount Extension Brackets on each side of window frame (1). Make sure to confirm that the headrail will sit perfectly level. Then, attach the mounting brackets using the nuts and bolts provided (2).

# INSTALLATION INSTRUCTIONS

## 4. Install the Shade

**IMPORTANT:** For motorized shades, attach the power source to the motor and pair the motor with the remote using the instructions included with the remote.

### 4a. For Cordless Lift Shades Only

#### Honeycomb Shades

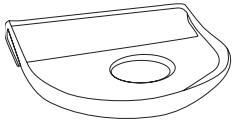

Cordless Handle

#### Hybrid Pleat Only



Clear Plastic Handle

The honeycomb cordless lift handle should be installed prior to mounting the shade in the window. The hybrid pleat handle will come pre-inserted into the moving rail(s).

**NOTE:** The hybrid pleat handle is not easily removable. Should it become necessary to remove the handle please contact customer service.

#### INSTALLING BOTTOM RAIL OPERATING HANDLE FOR BOTTOM-UP, TOP-DOWN/BOTTOM-UP AND TWO-FABRIC COMBINATION APPLICATION

**Note:** Shades over 42" in width will come with two handles per rail. If both handles are used they should be installed evenly across the rail.

- Locate the clear cordless bottom rail handle that arrived with your shade.
- Extend the shade, expanding the cells so they fully expose the bottom rail, allowing for an easier handle installation.
- Hook the lip of the handle over the top of the bottom rail.
- Once hooked under, pull the handle outward to ensure the handle has snapped into place.

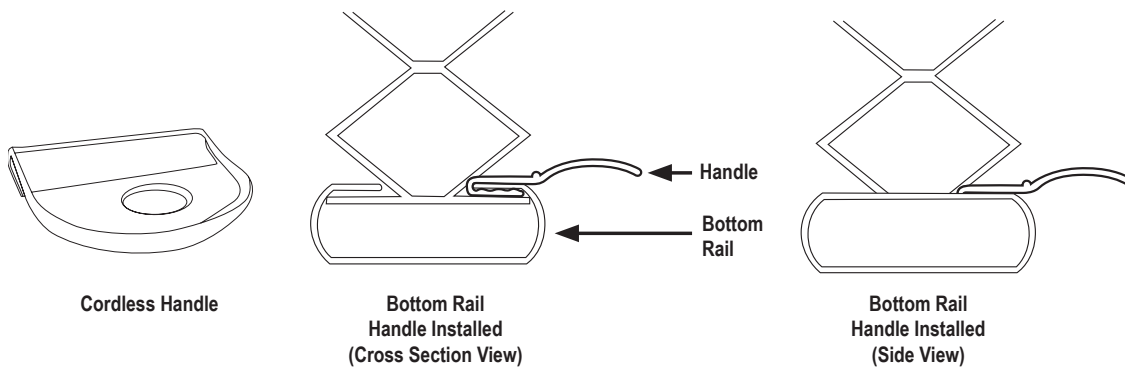

#### INSTALLING MIDDLE RAIL OPERATING HANDLE FOR TOP-DOWN/BOTTOM-UP AND TWO-FABRIC COMBINATION APPLICATION

**Note:** The middle rail handle is installed in an inverted position from the bottom rail handle.

- Locate the clear, cordless middle rail handle that arrived with your shade.
- Extend the shade, expanding the cells so they fully expose the middle rail, allowing for an easier handle installation.
- Hook the lip of the handle under the bottom of the middle rail.
- Once hooked under, pull the handle outward to ensure the handle has snapped into place.

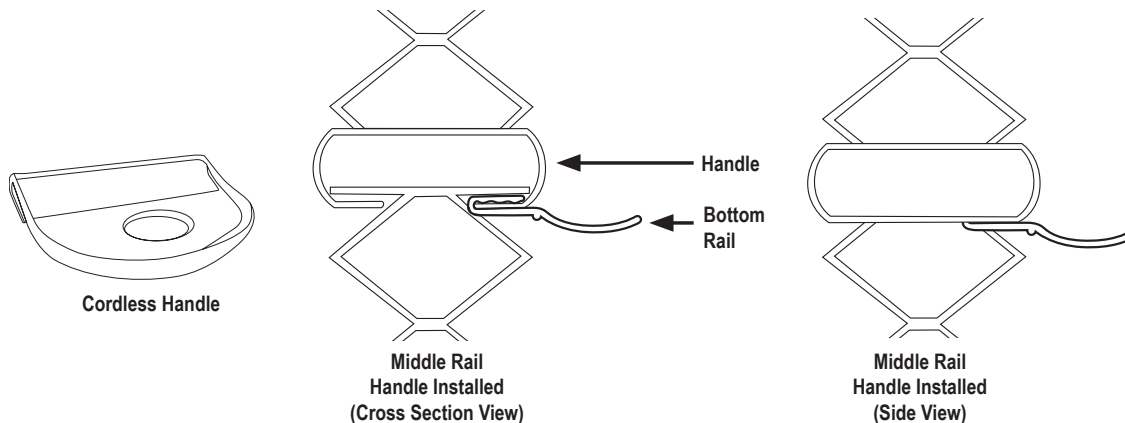

# INSTALLATION INSTRUCTIONS

## 4b. Mount the Headrail

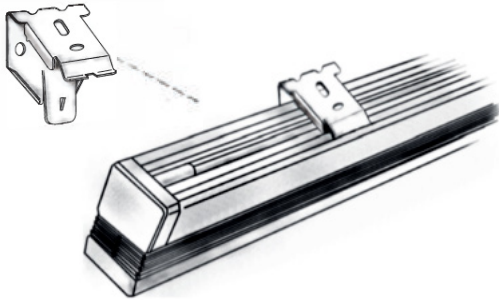

With the front side of the shade facing you, tilt the headrail slightly backward to angle the front inside lip to the brackets. Rotate headrail back and upward to snap in it into place.

## 5. Attaching the Cord Loop Tensioner

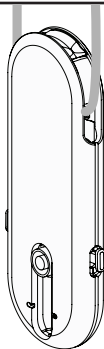

**NOTE:** For the shade to operate properly, the tensioner must be correctly mounted and secured.

Refer to the Installation Instructions included with the Universal Cord Tensioner.

## 6. Attach the Hold-Down Brackets (Optional)

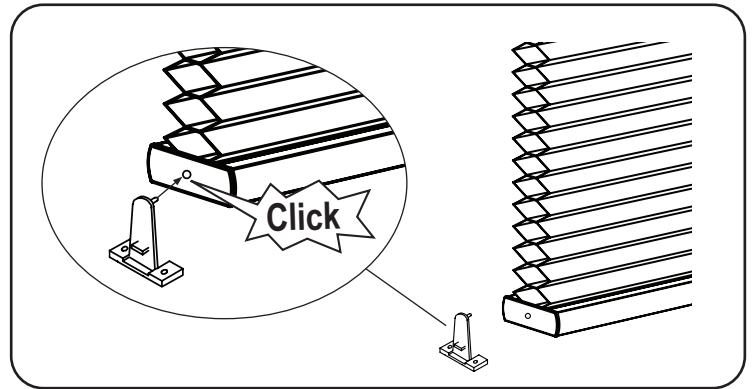

**IMPORTANT:** The bottom rail must be disconnected from the hold down brackets to raise the shade.

First, lower the shade and place the hold down pins into the hole on the bottom rail end caps. Then, mark the hold down bracket locations on the mounting surface. Center the hold down brackets over the mounting hold locations and check their alignment. Finally, attach the brackets using the screws provided.

## 7. Operate the Shade

### 7a. Continuous Cord Loop Shades Only

To raise and lower the shade, pull down on the cord loop to raise and lower. One side of the loop will raise the shade and one side will lower it. If the same cord is continuously pulled after lowering, the shade will begin to rise.

**NOTE:** Don't raise shade any higher than it was intended to go. If shade doesn't raise evenly, in most cases lowering it completely will allow cords to re-align on the spool.

### 7b. Cordless Lift Shades Only

To raise and lower the shade, hold the handle in the center portion of the bottomrail to ensure level movement.

**Lower the shade** by gently pulling downward to the desired position.  
**Raise the shade** by gently pushing upward to the desired position.

**Note:** Shades over 42" in width will have two handles evenly positioned within hands reach, along the center portion of the bottomrail to ensure level movement.

## 8. Adjust the Shade

Raise and lower the shade several times. If the length is incorrect or the bottom rail is not level, use the following steps to correct.

### For Bottomrail Shade Adjustment:

Lift bottomrail on the side to be adjusted.

### For Intermediate Rail Shade Adjustment:

Lift intermediate rail on the side to be adjusted.

This will take the weight off the cord. Using a screwdriver or dime:

- Turn screw clockwise to lift that side of the shade.
- Turn screw counter clockwise to lower that side of the shade.  
Half a revolution is 1/4" adjustment (maximum adjustment is 1/2").

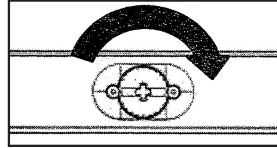
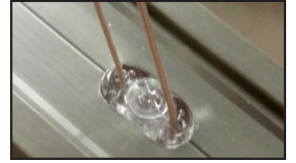

Lift Shade Side

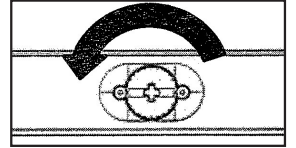

Lower Shade Side

## Troubleshooting

### THE SHADE WILL NOT SNAP INTO THE INSTALLATION BRACKETS.

- Check that the installation brackets are aligned and level.

### THE SHADE IS HARD TO RAISE OR LOWER, OR WILL NOT RAISE OR LOWER.

- Shades cannot be forced into tight inside mount window openings. If an inside mount, check that the shade is installed correctly. Make sure there is clearance between the ends of the shade and the window casement.
- Check that the installation brackets are level. Shim to level, if necessary.
- If hold-down brackets are used, make sure they have been released.
- Make sure the fabric is not caught.

### THE SHADE RAISES OR LOWERS UNEVENLY OR THE BOTTOM RAIL IS UNEVEN.

- Check that the window is square by measuring the diagonals.
- Check that the installation brackets are level. Shim to level, if necessary.
- Adjust the cords under the bottom rail (see “Adjust The Shade” on page 3).

### THE CORD TENSIONER GRABS ONTO THE CORD UPON OPERATION.

- Check that the cord tensioner is mounted properly. Reinstall, if necessary. Refer to the Universal Cord Tensioner Installation Instructions included with your cord loop shade.

### IMPORTANT INFORMATION REGARDING CORDLESS SHADE OPERATION.

- Daily operation of shade will ensure that it performs at its optimal level.
- If the shade is in the lowered position for an extended period of time, extra care needs to be taken when raising the shade. The fabric will relax and may resist lifting. This is a natural occurrence with all fabric shades. When lifting, you may notice the billowing (falling out) toward you. This is temporary and can be corrected by slowly raising the shade completely and then operating several times. This allows the fabric to go back to its pleated state, and the shade will operate as designed.
- If shade has been in the fully raised position for an extended period of time, it may have a tendency to “spring back” above the desired length of the shade. This is temporary and can be corrected by completely raising the shade and operating several times.
- Operating the shade with the handle(s) provided is recommended so that the shade is balanced when raising and lowering.
- Motorized Shades – see operating instructions guide included with shade/remote control.

## Child Safety

<p><b>⚠ WARNING</b></p> <p><b>⚠ ADVERTENCIA</b></p>	
<p><b>Window Blind Cord Strangulation Risk</b></p> <p>Window Blinds with a damaged or loose tension device or retractable cord that fails to fully retract pose a strangulation risk to children. To avoid this potential strangulation risk, consider purchasing cordless products or products with inaccessible cords.</p>	
<p><b>Riesgo de Estrangulamiento en Cuerdas de Persianas</b></p> <p>Las persianas con un dispositivo tensor suelto o dañado o con una cuerda retractable que no se ajusta completamente representan un riesgo de estrangulamiento para los niños. Para evitar un posible riesgo de estrangulamiento, considere comprar productos inalámbricos o productos con cuerdas inaccesibles.</p>	

## QUICK PROGRAMMING GUIDE

# POWERWAND™

Honeycomb Shades | Dual Shades | Roller Shades  
Sheer Shadings | Natural Woven Shades

### 1a. Attach the Wand — Sheer Shadings, Dual & Roller Shades

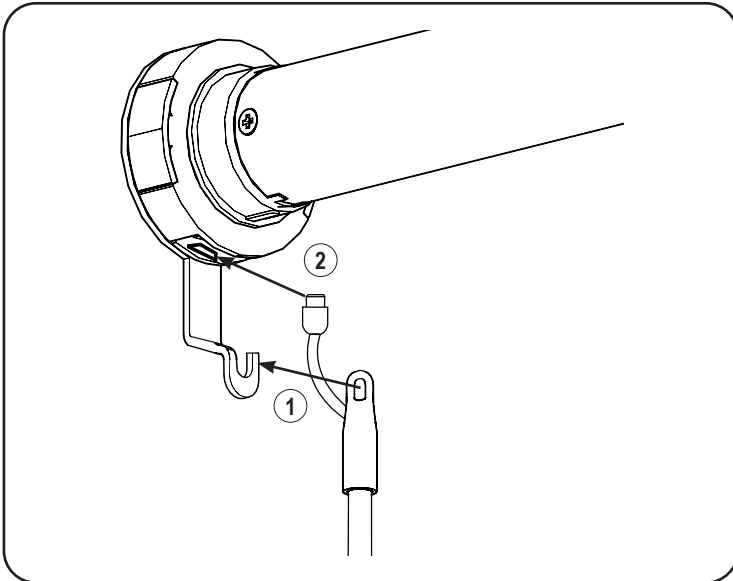

On Dual Shades, Roller Shades and Sheer Shadings, with the wand control buttons facing you, attached the top of the wand on the metal hook support (1) on the motor control side, then connect the cable into the motor head (2).  
**Note:** On Sheer Shadings ordered with Powerwand on the right side, the cable may be wrapped around the hook. This is normal. You may unwrap, if you desire, as this does not affect functionality. You still need to connect the cable into the motor head.

### 1b. Attach the Wand — Honeycomb Shades

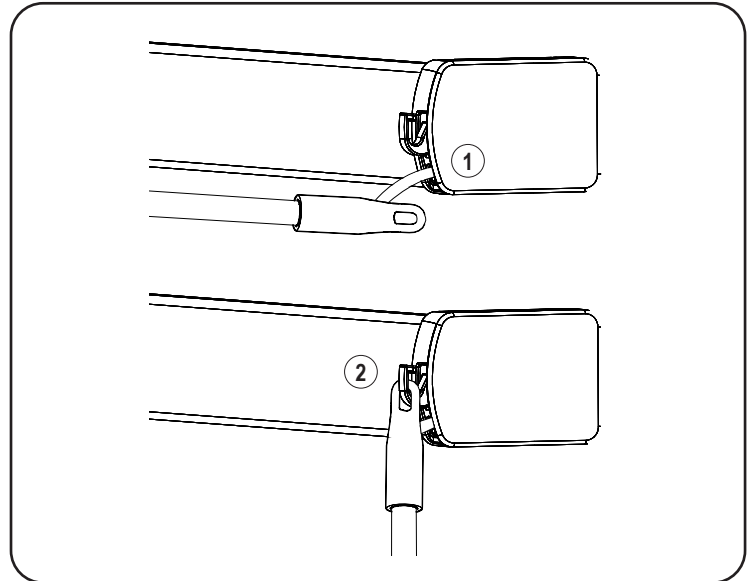

On Honeycomb shades, the wand will be already connected to the shade (1). With the wand control buttons facing you, attached the top of the wand into the plastic hook support on the motor control side (2).

### 1c. Attach the Wand — Natural Woven Shades

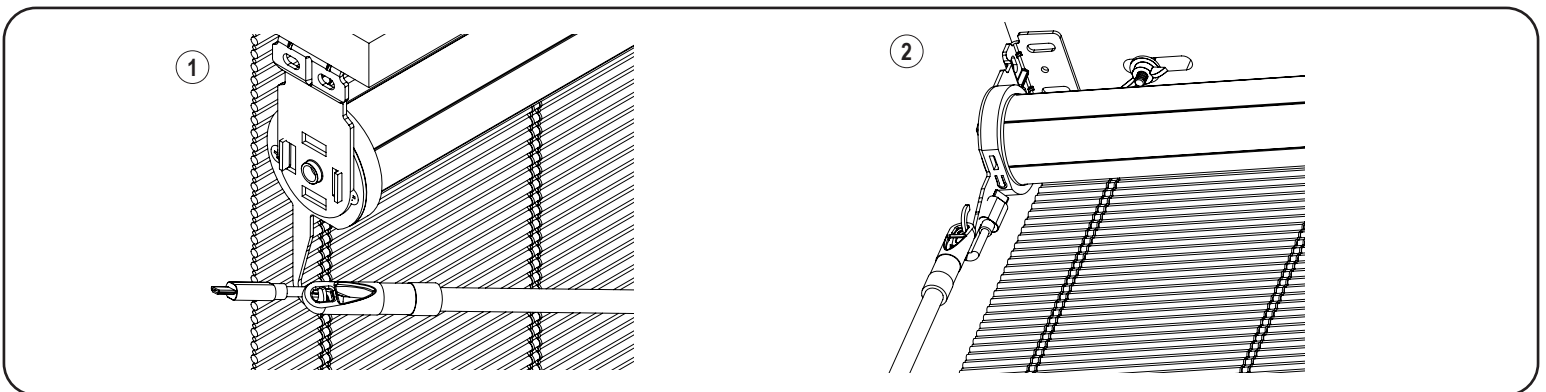

On Natural Woven Shades, with the wand control buttons facing you (1) approach the hook with the wand parallel to the headrail. (2) Gently twist the wand to attach it to the hook. Connect the cable into the motor.

**Important:** Before starting the programming, install the shade following the installation instructions provided.  
Honeycomb shades are shipped with the motor in sleep mode to avoid activation during transit.

**For Honeycomb Shades,** To wake up the motor prior to operating the shade: Press the STOP button 5 times (1) - the first 4 times press quickly and the 5th time PRESS and HOLD the stop button until the motor jog (2).

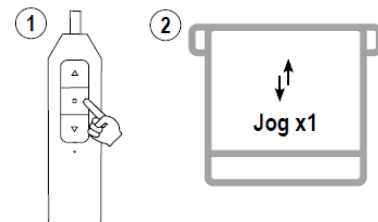

## 2. Operate the Wand

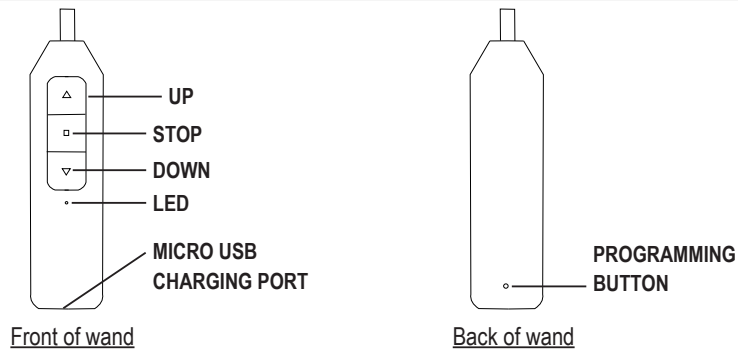

### Roller and Honeycomb Mode:

- Press the **DOWN** or **UP** button to lower or raise the shade. Press the **STOP** to stop the shade at the desired position.

### Sheer Shadings and Dual Shades Mode:

- Tapping the **UP** or **DOWN** button for less than 2 seconds will move the shade in short steps.
- Holding the **UP** or **DOWN** button down for more than 2 seconds before releasing will operate the shade at the standard speed.
- Press the **STOP** button to stop the shade at the desired position.

## 3. Set a Favorite Position

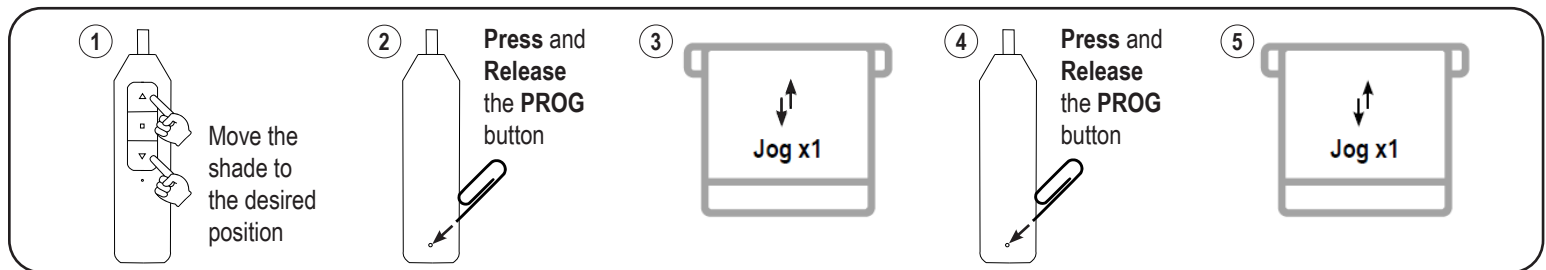

**IMPORTANT:** Once the favorite position is set, the shade will always stop at the designed favorite position when passing by it. Click 2 x Up or Down button, the shade will go to set Top or Bottom Limit.

## 4. Remove a Favorite Position

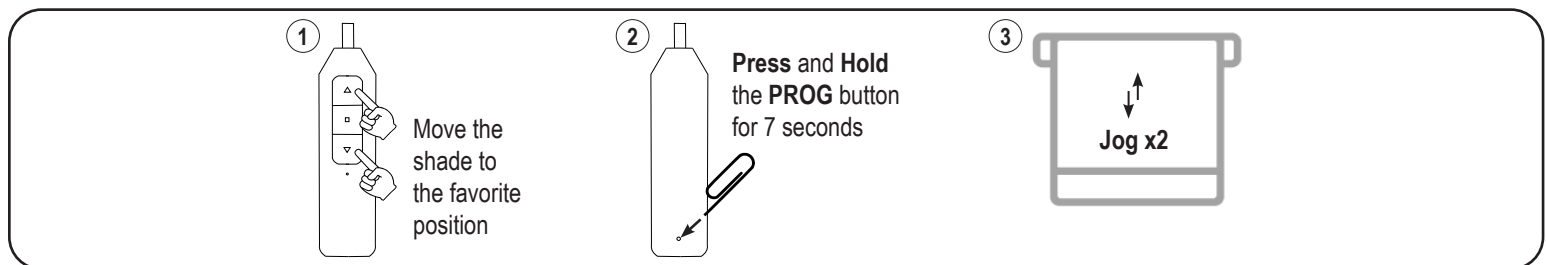

## 5. Advanced Programming

**IMPORTANT:** Damage to shade may occur when operating the motor prior to setting limits. Attention should be given.

### Switch between Roller and Sheer Shadings Mode

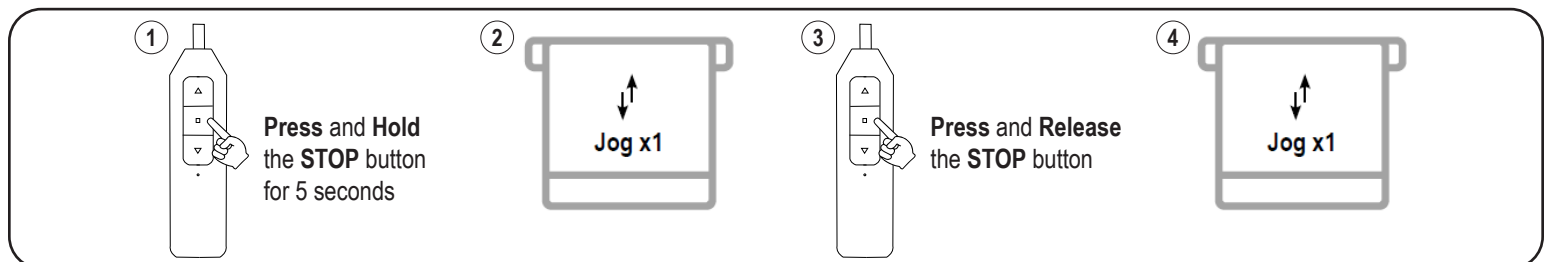



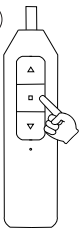
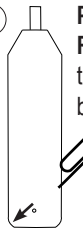
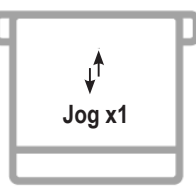
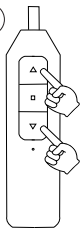
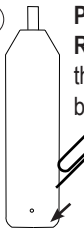
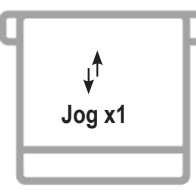

# QUICK PROGRAMMING GUIDE

## Adjust the Top and/or Bottom Limit

-  Move the shade to the limit that should be adjusted
-  Press and Release the **PROG** button
-  Jog x1
-  Adjust the shade to the desired limit position
-  Press and Release the **PROG** button
-  Jog x1

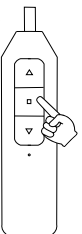
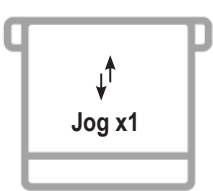
## Factory Motor Reset

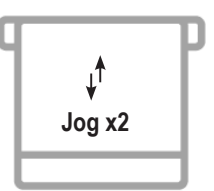

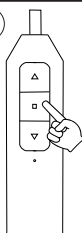
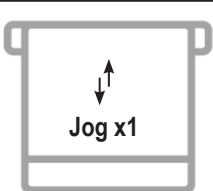
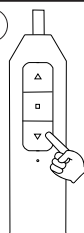
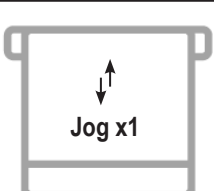

-  Press and Hold the **STOP** button for 5 seconds
-  Jog x1
-  Press and Hold the **PROG** button for 7 seconds
-  Jog x2

**IMPORTANT:** All limits will be erased. The motor direction will return to default and may need to be adjusted.

## Reverse UP and DOWN Commands (Only if necessary)

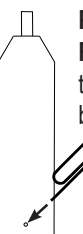
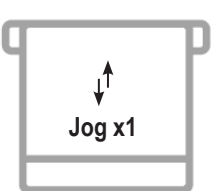
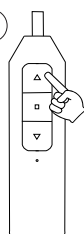
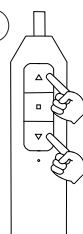
-  Press and Hold the **STOP** button for 5 seconds
-  Jog x1
-  Press and Release the **DOWN** button
-  Jog x1

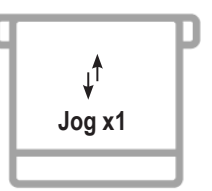
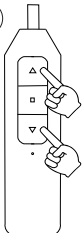
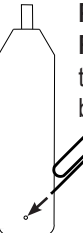
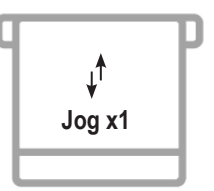
## Set Upper and Lower Limits ( Only after Factory Motor Reset)

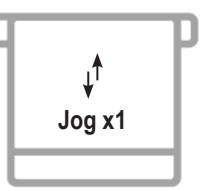
-  Press and Release the **PROG** button
-  Jog x1
-  Press **UP** to set the **TOP LIMIT**
-  Adjust the shade to the desired top limit
-  Press and Release the **PROG** button
-  Jog x1
-  Adjust the shade to the desired lower limit
-  Press and Release the **PROG** button
-  Jog x1
-  Press and Release the **PROG** button
-  Jog x1



6. Charge the Battery

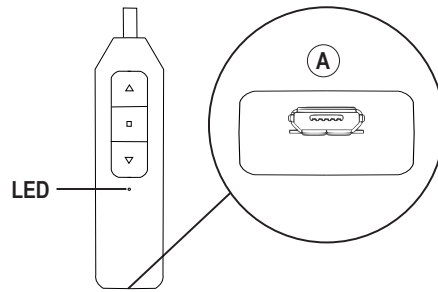

When the shade begins to operate slower than normal or only beeps when you attempt to operate, it is time to charge the battery.

To Charge, connect a standard micro USB cable into the bottom of the wand (A) and into USB 5V/2A (max) power supply. A red LED on the wand indicates that the battery is charging. To fully charge the batteries, allow the batteries to charge for at least 1 hour after the LED on the wand turns green.

**Note:** A typical charge cycle can take between 4-6 hours.

Troubleshooting

Issues	Possible Causes	Solution
The shade is not responding	Built in battery is depleted	Recharge with compatible USB 5V/2A (max) adapter and a micro USB cable. Details under "6. Charge the Battery"
	Wand is not fully connected to the motor	Check the connection between the wand and the motor
The shade moves the opposite direction on the control buttons	The motor direction is reversed	See details under "Reverse Up and Down Commands"
The shade stops by itself before it reaches the top or bottom limit	A favorite position was set	See details under "4. Remove a Favorite Position"
The shade only moves in small steps after pressing the button	The shade is operating on Sheer Shadings/ Dual Shades mode	Switch to Roller/Honeycomb mode by following the steps under "Switch between Roller and Sheer Shadings Mode"
	The shade has no limit set	See details under "Set Upper and Lower Limits"

Child Safety

**WARNING/ADVERTENCIA**  
5.1.3 Rev. 5/18 Print 5/18

Window Blind Cord Can **STRANGLE** Your Child. To prevent strangulation, purchase cordless products or products with inaccessible cords.  
 La cuerda de la persiana puede **ESTRANGULAR** a su niño. Para evitar el estrangulamiento, compre alternativas cuerda o productos con cuerdas inaccesibles.



1035121